

6 Tonne Power Swivel

MACH2264

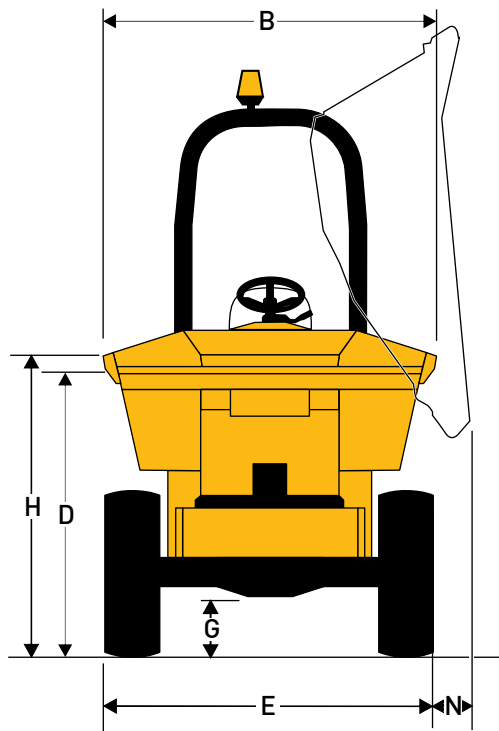
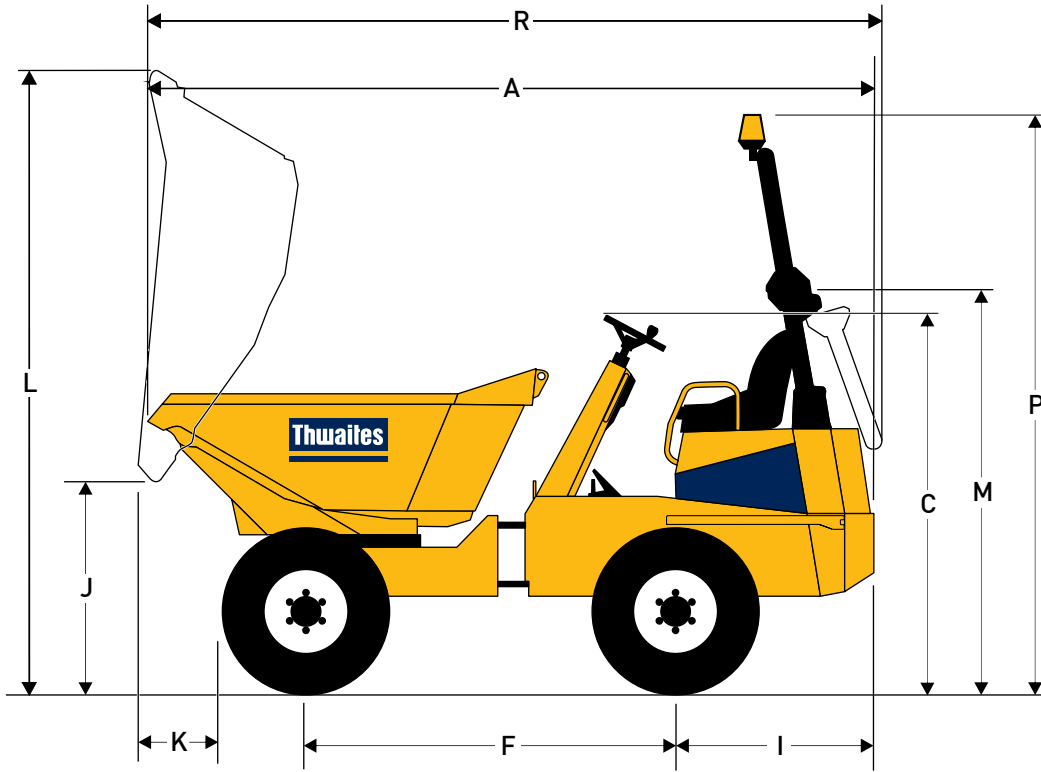

Dimensions (mm)

A	4815
B	2280
C	2230
D	1670
E	2240
F	2480
G	370
H	1850
I	1235
J	1100
K	550
L	3694
M	2230
N	100
P	3430
R	5082

► SPECIFICATIONS

6 Tonne Power Swivel

MACH2264

Capacities	Max safe load	6000kg
	Heaped	3150 litres
	Struck	2550 litres
	Water	1650 litres

Engine

Deutz TCD 3.6 L4 55.4kW/74hp at 2200rpm, water-cooled, 4-cylinder, charged air cooled turbo, electronic controlled fuel injected diesel engine. Powercore air intake filter and stainless steel exhaust system, including after treatment Diesel Particulate filter providing conformity to EU Stage V emission regulations. Peak torque 405Nm at 1300 rpm.

Noise Levels

Operator's ear 84 LpA, airborne sound level 102 LwA

Transmission

Torque converter four speed forward and reverse Powershift transmission with changes of speed and forward/reverse direction controlled by one column mounted lever. With heavy duty gear driven transfer box.

Speeds	Forward and Reverse	
	1	4.8km/h (3.0 mph)
	2	8.6km/h (5.4 mph)
	3	15.6km/h (9.8 mph)
	4	27.7km/h (17.3 mph)

Tyres	405/70 x 20
	Track grip tread
	Load/Speed Index 142 A8

Brakes and Axles

Twin circuit totally enclosed multiplate oil immersed discs, mounted on both axles with automatic adjustment for wear. Hand-operated parking brake, spring applied hydraulically released brakes (SAHR). Heavy duty axles with epicyclic reduction and fully floating half shafts.

Kinglink Chassis

Front and rear chassis constructed from deep section folded steel plate, with three point Kinglink giving articulation and oscillation for better stability, traction and extra safety on site. Remote greasing point provided for lubrication of top Kinglink articulation pin.

Skip

Hydraulically operated, 8 mm steel base plate, fully welded, reinforced with box section giving greater strength to minimise skip damage. No material traps. Powerswivel mounted on a ball bearing turntable with powered rotation through 180° by means of twin slewing cylinders, operated by a single dual-axis control lever. Automatic safety lock holds skip in central position when travelling.

Seating & Controls

Adjustable suspension seat, fitted with high visibility rigid seat belt with adjustable web, accessible from both sides. Audible warning device for handbrake in "on" position, electric horn, large pedal pads, ignition key, park brake and skip controls ready to hand. Clear operators display unit contains all warning lamps plus LED screen to show Fuel level, Hourmeter, Tachometer, Engine coolant temperature, Error codes and description should an engine error occur.

Service Access

Lockable three sided cover opens to provide easy access from ground level to engine service points, all located on the same side. Rear chassis panel can be hinged back on retainers. An additional service access door incorporates the battery. Moulded plastic diesel tank and steel hydraulic tank are positioned low in chassis side members, permitting access to the filler caps from ground level.

Electrics

Engine control unit (ECU) monitors all engine/emission related systems, if necessary, reducing engine power/speed (including engine shut-down). Fuse & relay are clearly marked and housed on a central power distribution board. Main harness is fully enclosed in solid conduit and incorporates the engine diagnostic port.

Steering and Hydraulics

Single gear pump providing hydraulic functions includes priority power steering. Filter mounted on top of the tank accessible from ground level. Hydraulic test point fitted as standard.

Tank Capacities	Fuel	72 litres
	Hydraulic	50 litres

Shipping Cube	25.8 m ³ (with ROPS)
---------------	---------------------------------

Unladen Weight	4540kg
----------------	--------

Clearance Diameter	12m
--------------------	-----

Standard Equipment

Full LED road lighting Incl. DRL (Daylight Running Lights), Camera and Dashpanel Monitor, Towing bracket, Folding ROPS frame, LED Beacon (Amber), Fan guard, Low fuel level warning, Water in fuel warning, Low Brake Fluid warning, High visibility rigid seat belt, Reverse alarm.

Optional Extras

Road mirrors, Wheel Nut Indicator, GPS Speedometer, Trackunit.

Distributor



Thwaites Ltd. Leamington Spa, Warwickshire CV32 7NQ, England
 Tel +44 (0)1926 422471 Fax +44 (0)1926 337155
 www.thwaitesdumpers.co.uk



We reserve the right to change all specifications without prior notice. Printed in England 10/2019